

Adjustable feet, sanitizable

(base in stainless steel)

Part. **103** \varnothing **95**

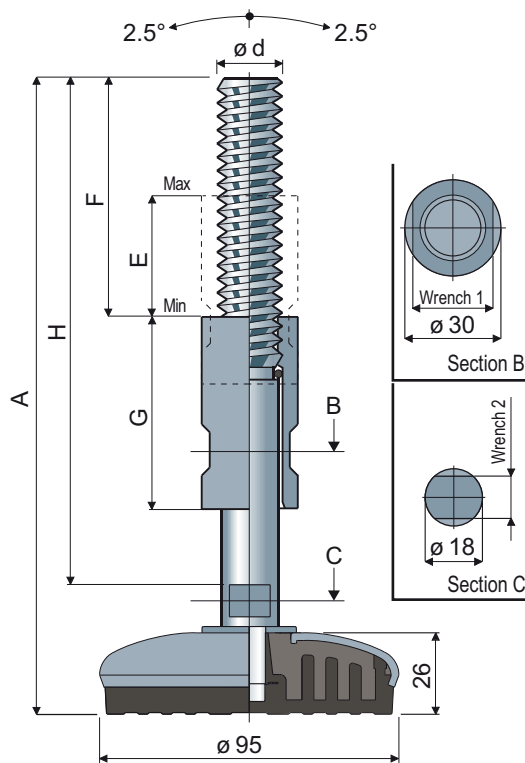

Spindle measures in mm								Spindle and base in stainless steel AISI 304		Max static load (N)
$\varnothing d$	A	H	F	E	G	Wrench 1	Wrench 2	Code		
M20	200	157	73	39	60	25	13	103 / 83465	27000	
	260	217	100	78	100	25	13	103 / 84191		

Material: Internal part made of reinforced polyamide; external covering made of stainless steel AISI 304; anti-slip pad made of soft PVC 68 Shore black colour.

Box quantity: 8 pieces.

Features: Comoulded anti-slip pad allows a perfect adherence with steel base. Consequent absence of internal cavities makes foot extremely cleanable. The threaded insert guarantees the protection of the spindle thread.

Washers UNI 6592-69 - Box quantity: 24 pieces.

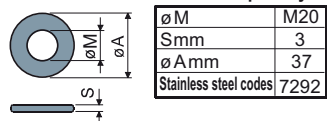

Nuts UNI 5588-65 - Box quantity: 24 pieces.

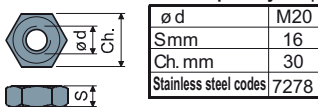

On request

- Spindles with: Sunk hexagon head • second wrench seat head • hexagon wrench seat • threads with other pitches and lengths.
- Anti-slip pads: White color.
- Box quantity: Not standard.
- Assembling of: Nuts • washers.