

# FITTINGS



**Clamp Fittings**



## CLAMP FITTINGS....

Clamp Style Fittings are most popular for easy assembly and breakdown of process lines and equipment. VNE offers Clamp Fittings in T304 and T316L materials in 1/2" through 12" sizes.

Gaskets for Clamp Fittings are available in several different materials, Buna-N, EPDM, Silicone, Tef-Steel®, Teflon®, and Viton®. Lightweight and heavy-duty clamps complete the unions. VNE's Clamp Fittings meet all 3A requirements.

## CLAMP FITTING SPECIFICATIONS....

**Size Range:** 1/2" OD through 12" OD

**Materials:** T304  
T316L

**Finish:** No. 7 - ID & OD  
No. 5 - OD only  
No. 3 - ID only  
No. 1 - unpolished

## ORDERING SPECIFICATIONS....

- Specify:**
- Quantity
  - Product description or Part No.
  - Size
  - Material Type
  - Polish Requirements

## LIMITED WARRANTY....

VNE Corporation products are warranted to be free from defects in material and workmanship for a period of one year from the date of shipment. Any product that proves to be defective shall be repaired or replaced at the option of VNE, providing it has been used as recommended and in strict accordance with recognized piping practices, and that has not been subject to extraordinary service, such as encountered under severe corrosive or abrasive conditions.

VNE makes no warranties, express or implied, other than those listed above.

VNE shall not be liable for any consequential, indirect, incidental or contingent damages.

## VNE CORPORATION

P.O. Box 1698 • 1149 Barberry Drive • Janesville, WI 53547  
TEL: 608-756-4930 • FAX: 608-756-3643 • 1-800-356-1111 • Web site: [vnestainless.com](http://vnestainless.com)

### CLAMP TYPE

VNE	TRI-CLOVER	WAUKESHA	G & H	JENSEN
EG2C	2CMP	2CMP	GC2C	JC2
EGLC31CC	2CMP-31MP	2CMP-31MP	GC2C-31	JC2-J31
EG2FPR	2FMP-14	2FMP-14	GC2F-14	JC2-14
EG2WU	-----	-----	GC2WU	J2WU
EG2FTR	2FMP-15	2FMP-15	GC2F-15	JC2-15
EG2K	2KMP	2KMP	GC2K	JC2K
EG7	7MP	7MP	GC7	JC7
EG7R	7RMP	7RMP	GC7R	JC7R
EG9	9MP	9MP	GC9	JC9
EG13	13MHLA	-----	GH13FAH	K13LH
13MHHM	13MHHM	13MHHM	GC13LAH	JC13HC
13MHP	13MHP	13MHP	13MHP	JC13HP
EG14HT	14MPHT	14MPHT	GC14AHT	JC14AHT
EG14W	14MPW	14MPW	GC14W	JC14H
EG14WL	14WLMP	14WLMP	GC14WL	JC14
EG14AM7	L14AM7	L14AM7	GC14AC	JC14AM7
EG2CS	14WMP	14WMP	GC2CS	JC14X
EG14RT	14MPHR	14MPHR	GC14AHR	JC14AHR
EG16A	16AMP	16AMP	GC16A	JC16
EG17PR	17MP-14	17MP-14	GC17PC	JC17-14
EG17TR	17MP-15	17MP-15	GC17TC	JC17-15
EG21	21MP	21MP	GC21	JC21
EG22	22MP	22MP	GC22	JC22
EG31R	31RMP	31RMP	GC31R	JC31R
EG31CC	31-14MP	31-14MP	GC31CC	JC31
EG32CC	32-14MP	32-14MP	GC32CC	JC32
EG31PC	31PMP	31PMP	GC31PC	J14-C31
EG32PC	32PMP	32PMP	GC32PC	J14-C32
EG31CP	31MPP	31MPP	GC31CP	JC31-14
EG32CP	32MPP	32MPP	GC32CP	JC32-14
EG31TC	31TMP	31TMP	GC31TC	J15-C31
EG32TC	32TMP	32TMP	GC32TC	J15-C32
EG31CT	31MPT	31MPT	GC31CT	JC31-15
EG32CT	32MPT	32MPT	GC32CT	JC32-15
EG40	40MPU	40MPU	GC40	JC40N
EG40T	40MPG	40MPG	GC40T	JC40T
EG45BY	45BYMP	45BYMP	GC45SH	-----
45C	B45MP	45HMP	-----	45HC
EG23B	23BMP	23BMP	GC23B	JC23B
EG28A	28AMP	28AMP	GC28A	JC28A
EG28B	28BMP	28BMP	GC28B	JC28B

## EG2C - 90° ELBOW

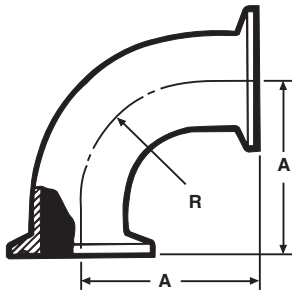

Size Tube OD	A	R
1	2.000	1.500
1 1/2	2.750	2.250
2	3.500	3.000
2 1/2	4.250	3.750
3	5.000	4.500
4	6.625	6.000
6	9.875	9.000
8	12.937	12.000

## EG2WU - CLAMP 180° U-BEND

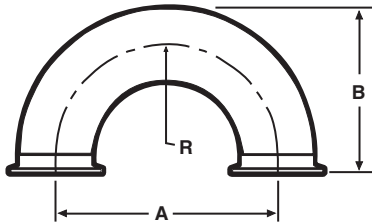

Size Tube OD	A	B	R
1/2	1.500	1.500	0.750
3/4	2.250	2.000	1.125
1	3.000	2.500	1.500
1 1/4	3.750	3.000	1.875
1 1/2	4.500	3.500	2.250
2	6.000	4.500	3.000
2 1/2	7.500	5.500	3.750
3	9.000	6.500	4.500
4	12.000	8.625	6.000
6	18.000	12.875	9.000

## EG2FPR - 90° ELBOW

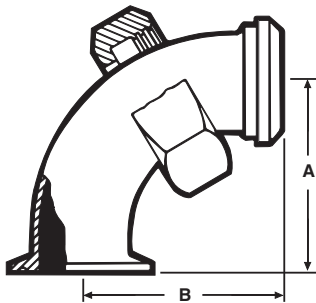

Size Tube OD	A	B
1	2.000	2.875
1 1/2	2.750	2.968
2	3.500	3.718
2 1/2	4.250	4.593
3	5.000	5.406
4	6.625	7.218

## EG2FTR - 90° ELBOW

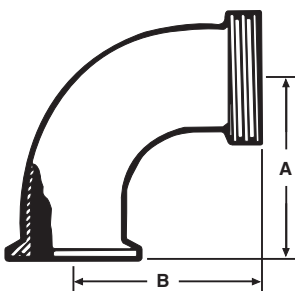

Size Tube OD	A	B
1	2.000	2.187
1 1/2	2.750	2.968
2	3.500	3.718
2 1/2	4.250	4.593
3	5.000	5.406
4	6.625	7.218

Note: One inch fittings take 1 1/2" clamps.  
Fractional fittings take 3/4" clamps.

## EG2C31CC - 90° REDUCING ELBOW (Non-Tapered)

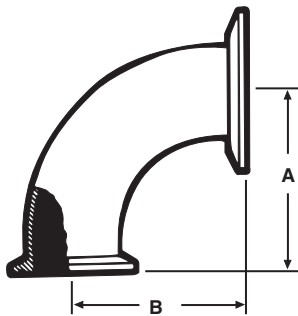

Size Tube OD	A	B
2 x 1	2.000	2.000
2 x 1 1/2	2.750	2.750
2 1/2 x 1 1/2	2.750	2.750
2 1/2 x 2	3.500	3.500
3 x 1 1/2	2.750	2.750
3 x 2	3.500	3.500
3 x 2 1/2	4.250	4.250
4 x 2 1/2	4.250	4.375
4 x 3	5.000	5.125
6 x 4	6.625	6.875

## EG231-FPR 90° REDUCING ELBOW (Non-Tapered)

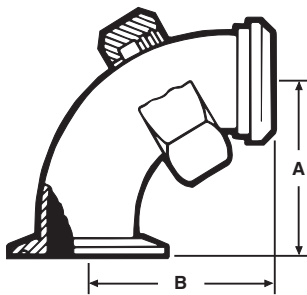

Size Tube OD	A	B
2 x 1	2.000	2.187
2 x 1 1/2	2.750	2.968
2 1/2 x 1 1/2	2.750	2.968
2 1/2 x 2	3.500	3.718
3 x 1 1/2	2.750	2.968
3 x 2	3.500	3.718
3 x 2 1/2	4.250	4.593
4 x 2 1/2	4.375	4.593
4 x 3	5.125	5.406

## EG2C31PR - 90° REDUCING ELBOW (Non-Tapered)

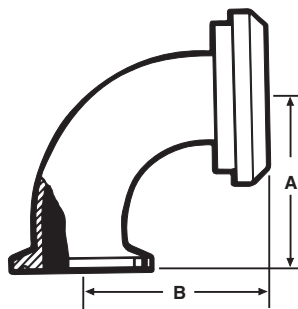

Size Tube OD	A	B
2 x 1	2.000	2.250
2 x 1 1/2	2.750	3.000
2 1/2 x 1 1/2	2.750	3.031
2 1/2 x 2	3.500	3.781
3 x 1 1/2	2.750	3.593
3 x 2	3.500	3.843
3 x 2 1/2	4.250	4.593
4 x 2 1/2	4.250	4.687
4 x 3	5.000	5.437

Note: One inch fittings take 1 1/2" clamps.  
Fractional fittings take 3/4" clamps.

## EG2K - 45° ELBOW

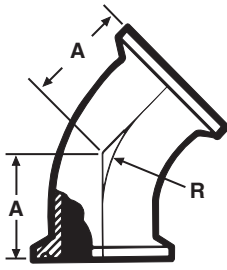

Size Tube OD	A	R
1	1.125	1.500
1 1/2	1.437	2.250
2	1.750	3.000
2 1/2	2.062	3.750
3	2.375	4.500
4	3.125	6.000
6	4.625	9.000
8	5.312	12.000

## EG7 - TEE

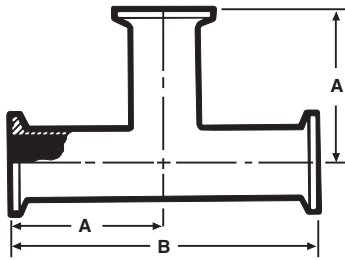

Size Tube OD	A	B
1	2.375	4.750
1 1/2	2.750	5.500
2	3.500	7.000
2 1/2	3.500	7.000
3	3.750	7.500
4	4.500	9.000
6	6.500	13.000
8	9.937	19.875

## EG7R - REDUCING TEE

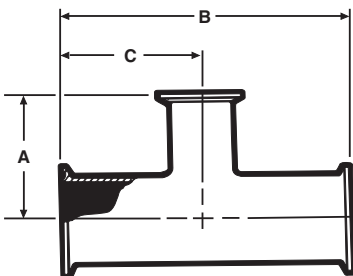

Size Tube OD	A	B	C
1 1/2 x 1	1.875	4.312	2.156
2 x 1	2.125	5.125	2.562
2 x 1 1/2	2.406	5.125	2.562
2 1/2 x 1 1/2	2.656	5.687	2.843
2 1/2 x 2	2.812	5.687	2.843
3 x 1 1/2	2.906	6.187	3.093
3 x 2	3.062	6.187	3.093
3 x 2 1/2	3.093	6.187	3.093
4 x 2	3.593	8.125	4.062
4 x 2 1/2	3.593	8.125	4.062
4 x 3	3.593	8.125	4.062
6 x 3	6.125	13.000	6.500
6 x 4	6.250	13.000	6.500

Note: One inch fittings take 1 1/2" clamps.  
Fractional fittings take 3/4" clamps.

## EG9 - CROSS

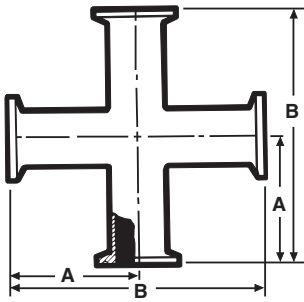

Size Tube OD	A	B
1	2.375	4.750
1 1/2	2.750	5.500
2	3.500	7.000
2 1/2	3.500	7.000
3	3.750	7.500
4	4.500	9.000
6	8.875	17.340

## EG14AM7 - WELDING FERRULE

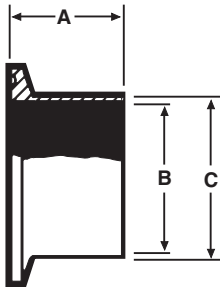

Size Tube OD	A	B	C
1/2	2.000	0.370	0.500
3/4	2.000	0.620	0.750
1	1.125	0.870	1.000
1 1/2	1.125	1.370	1.500
1 1/4	1.125	1.120	1.250
2	1.125	1.870	2.000
2 1/2	1.125	2.370	2.500
3	1.125	2.870	3.000
4	1.125	3.834	4.000
5	1.500	4.782	5.000
6	1.500	5.780	6.000
8	1.500	7.782	8.000
10	1.500	9.732	10.000
12	1.500	11.732	12.000

## EG14R - RECESSLESS FERRULE (Expanding)

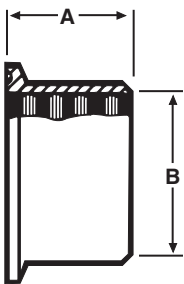

Size Tube OD	A	B
1	0.750	1.000
1 1/2	1.125	1.500
2	1.312	2.000
2 1/2	1.375	2.500
3	1.437	3.000
4	1.500	4.000

Note: One inch fittings take 1 1/2" clamps.  
Fractional fittings take 3/4" clamps.

## EG2CS - SHORT WELDING FERRULE

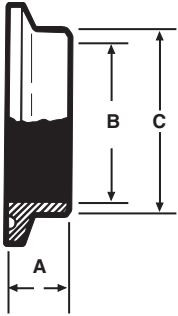

Size Tube OD	A	B
1/4	0.500	0.120
3/8	0.500	0.245
1/2	0.500	0.370
5/8	0.500	0.495
3/4	0.500	0.620
1	0.500	0.870
1 1/4	0.500	1.120
1 1/2	0.500	1.370
2	0.500	1.870
2 1/2	0.500	2.370
3	0.500	2.870
4	0.625	3.834
5	0.750	4.780
6	0.875	5.780
8	0.937	7.782
10	0.937	9.732
12	0.937	11.732

## EG2CS31D - SHORT REDUCING CLAMP FERRULES

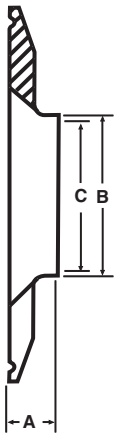

Size Tube OD	A	B	C
1 x 1/2	0.500	0.500	0.370
1 x 3/4	0.500	0.750	0.620
1 1/2 x 1	0.500	1.000	0.870
2 x 1	0.500	1.000	0.870
2 x 1 1/2	0.500	1.500	1.370
2 1/2 x 1 1/2	0.500	1.500	1.370
2 1/2 x 2	0.500	2.000	1.870
3 x 1	0.500	1.000	0.870
3 x 1 1/2	0.500	1.500	1.370
3 x 2	0.500	2.000	1.870
3 x 2 1/2	0.500	2.500	2.370
4 x 1 1/2	0.625	1.500	1.370
4 x 2	0.625	2.000	1.870
4 x 2 1/2	0.625	2.500	2.370
4 x 3	0.625	3.000	2.870
6 x 4	0.870	4.000	3.834

**Note: One inch fittings take 1 1/2" clamps.  
Fractional fittings take 3/4" clamps.**



## EG14W - TANK WELDING FERRULE

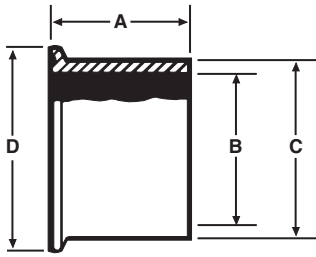

Size Tube OD	A	B	C	D
1	1.625	0.870	1.160	1.984
1 1/2	1.625	1.370	1.676	1.984
2	1.750	1.870	2.192	2.516
2 1/2	1.750	2.370	2.708	3.047
3	1.812	2.870	3.224	3.579
4	2.125	3.834	4.256	4.682
6	4.250	5.782	6.500	6.570

## EG14W-C6L - ASME CODED TANK FERRULE

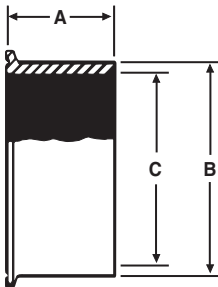

Size Tube OD	A	B	C
1	1.625	1.160	0.870
1 1/2	1.625	1.676	1.370
2	1.750	2.192	1.870
2 1/2	1.750	2.708	2.370
3	1.812	3.224	2.870
4	2.125	4.256	3.834
6	4.250	6.500	5.782

## EG14WSL-C6L - ASME CODED TANK FERRULE LONG

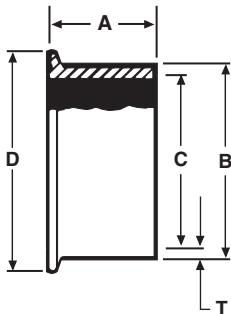

Size Tube OD	A	B	C	D	Nom. Wall (T)
1	2.500	1.160	0.870	1.984	0.145
1 1/2	2.500	1.676	1.370	1.984	0.153
2	2.500	2.192	1.870	2.516	0.161
2 1/2	3.500	2.708	2.370	3.047	0.169
3	4.500	3.224	2.870	3.579	0.177
4	4.500	4.256	3.834	4.682	0.211
6	6.250	6.500	5.782	6.570	0.359

Note: One inch fittings take 1 1/2" clamps.  
Fractional fittings take 3/4" clamps.

## EG14WL - TANK WELDING FERRULE

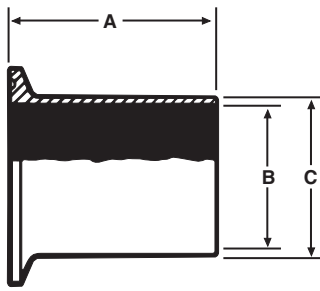

Size Tube OD	A	B	C
1	3.000	0.870	1.000
1 1/2	3.000	1.370	1.500
2	3.000	1.870	2.000
2 1/2	3.000	2.370	2.500
3	4.000	2.870	3.000
4	4.000	3.834	4.000
6	6.000	5.782	6.000
8	6.000	7.782	8.000
10	6.000	9.730	10.000
12	6.000	11.730	12.000

## EG14RT - RUBBER HOSE ADAPTER

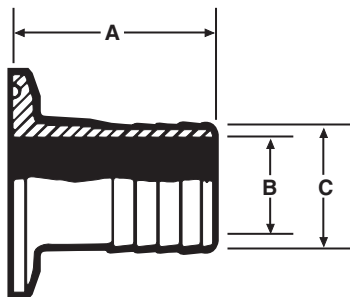

Size Tube OD	A	B	C
1/2	2.000	0.370	0.500
3/4	2.000	0.620	0.750
1	3.500	0.870	1.000
1 1/4	3.500	1.185	1.250
1 1/2	3.500	1.370	1.500
2	3.500	1.870	2.000
2 1/2	3.500	2.370	2.500
3	3.500	2.870	3.000
4	3.625	3.834	4.000
6	8.875	5.782	6.000

## EG14RT - RUBBER HOSE ADAPTER REDUCER (T316L)

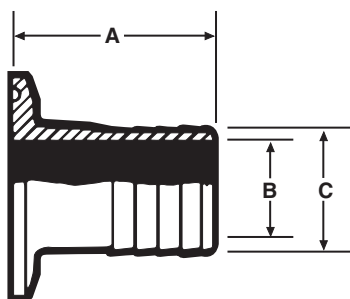

Size Tube OD	A	B	C
1 x 1/2	2.000	0.370	0.500
1 x 3/4	2.000	0.620	0.750
1 1/2 x 1 1/4	3.500	1.120	1.250
2 x 1	3.500	0.870	1.000
2 x 1 1/2	3.500	1.370	1.500
2 1/2 x 2	3.500	1.870	2.000
3 x 2	3.500	1.870	2.000
3 x 2 1/2	3.500	2.370	2.500
4 x 2 1/2	3.625	2.370	2.500
4 x 3	3.625	3.870	3.000

**Note: One inch fittings take 1 1/2" clamps.  
Fractional fittings take 3/4" clamps.**

## EG14HT - TYGON HOSE ADAPTER

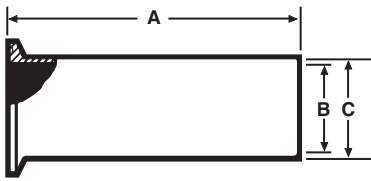

Size Tube OD	A	B	C
1	4.500	0.870	1.000
1 1/2	4.500	1.370	1.500
2	4.500	1.870	2.000
2 1/2	4.500	2.370	2.500
3	4.500	2.870	3.000
4	4.625	3.834	4.000

## EG17PR - ADAPTER

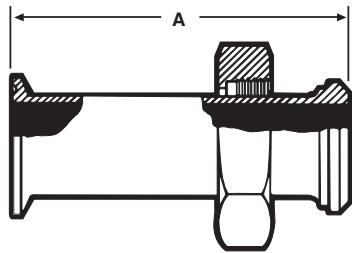

Size Tube OD	A
1	2.500
1 1/2	2.625
2	2.625
2 1/2	2.875
3	2.875
4	2.875

## EG17TR - ADAPTER



Size Tube OD	A
1	1.187
1 1/2	1.187
2	1.218
2 1/2	1.343
3	1.437
4	2.125

## EG21 - MALE ADAPTER (N.P.T. Pipe Threads)

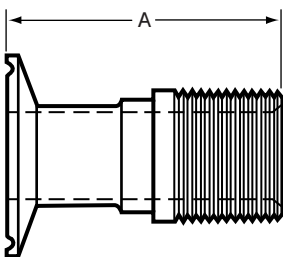

Size Tube OD	A
1	2.875
1 1/4	2.875
1 1/2	2.875
2	2.937
2 1/2	3.437
3	3.625
4	3.812
6	4.875

1 inch through 4 inch are supplied with wrench flats

Note: One inch fittings take 1 1/2" clamps.  
Fractional fittings take 3/4" clamps.

## EG21-6L - MALE ADAPTER REDUCING (T316L)

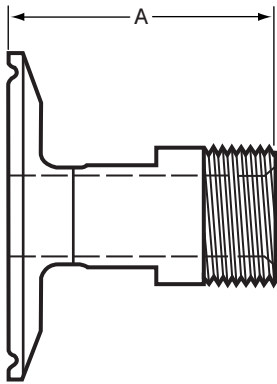

Size Tube OD	A
3/4 x 1/2	See MaxPure Catalog - TEG21
1 x 1/2	2.125
1 x 3/4	2.125
1 1/2 x 1/2	2.125
1 1/2 x 3/4	2.125
1 1/2 x 1 1/4	2.250
2 x 1	2.250
2 x 1 1/4	2.250
2 x 1 1/2	2.250
2 1/2 x 1 1/2	2.250
2 1/2 x 2	2.312
3 x 1 1/2	2.250
3 x 2	2.312
3 x 2 1/2	2.812
4 x 2	2.312
4 x 2 1/2	2.812
4 x 3	3.000
6 x 4	3.062

Sanitary end dimension listed first.

## EG22 - FEMALE ADAPTER (N.P.T. Pipe Threads)

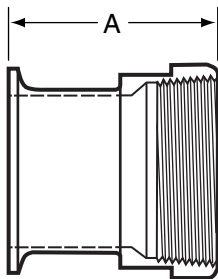

Size Tube OD	A
1	2.250
1 1/4	2.562
1 1/2	2.562
2	2.562
2 1/2	2.750
3	2.937
4	3.125

1 inch through 4 inch are supplied with wrench flats

**Note: One inch fittings take 1 1/2" clamps.  
Fractional fittings take 3/4" clamps.**

## EG22 - FEMALE ADAPTER REDUCING (T316L)

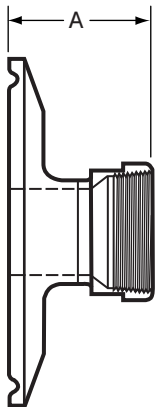

Size Tube OD	A
3/4 x 1/2	See MaxPure Catalog - TEG22
1 x 1/2	1.625
1 x 3/4	1.625
1 1/2 x 1/2	1.625
1 1/2 x 3/4	1.625
1 1/2 x 1 1/4	2.560
2 x 1	1.625
2 x 1 1/4	1.927
2 x 1 1/2	1.937
2 1/2 x 1 1/2	1.937
2 1/2 x 2	1.937
3 x 1 1/2	1.937
3 x 2	1.937
3 x 2 1/2	2.125
4 x 2	2.062
4 x 2 1/2	2.250
4 x 3	2.437

Sanitary end dimension listed first.

## EG16A - SOLID END CAP



Size Tube OD	A	B
1/2 & 3/4	0.992	0.200
1 & 1 1/2	1.984	0.250
2	2.516	0.250
2 1/2	3.047	0.250
3	3.579	0.250
4	4.682	0.312
5	5.692	0.385
6	6.570	0.437
8	8.570	0.437
10	10.570	0.562
12	12.570	0.625

1 1/2" caps are used on both 1" and 1 1/2" lines.

3/4" caps are used on both 1/2" & 3/4" lines.

**Note: One inch fittings take 1 1/2" clamps.  
Fractional fittings take 3/4" clamps.**

## EG23B-6L - CLAMP THERMOMETER CAPS (T316L)

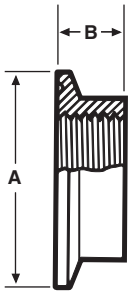

Size Tube OD	A	B
*1	1.984	0.625
1 1/2	1.984	0.625
2	2.516	0.625
2 1/2	3.047	0.625
3	3.579	0.625
4	4.682	0.625

\*STD - 1/2 FNPT. All others 3/4" FNPT

Note: Other tap sizes are available.

## GASKETS



Gasket Materials	Part Number	Flange Type
Buna N	EG40	EG40F
EPDM	EG40E	EG40FE
Teflon	EG40T	
Viton®	EG40V	EG40FV
Silicone	EG40S	EG40FS
TEF-Steel	EG40TS	

### Envelope Type

Teflon with EPDM Filler

EG40GR

Teflon with Viton Filler

EG40GRV

Available in 1/2" to 12" sizes.

## 13MHM - HEAVY DUTY CLAMP

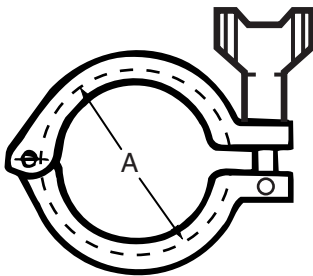

Size Tube OD	A
3/4	1.125
1 1/2	2.122
2	2.654
2 1/2	3.185
3	3.717
4	4.820
5	5.817
6	6.695
8	8.695
10	10.695
12*	12.695

Wing Nuts tightened to 25 in-lbs of torque

\*12" Clamp is a two piece design using two wingnuts and no hinge.

**Note: One inch fittings take 1 1/2" clamps.  
Fractional fittings take 3/4" clamps.**

## 13MHM-H - HEAVY DUTY CLAMP (Wing Nut With Hole)

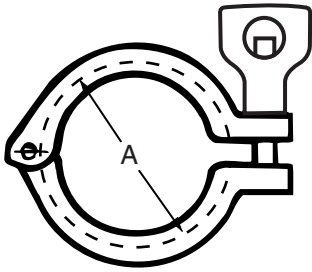

Size Tube OD	A
3/4	1.125
1 & 1/2	2.122
2	2.654
2 1/2	3.185
3	3.717
4	4.820
5	5.817
6	6.695
8	8.695
10	10.695
12	12.695

Wing Nuts tightened to 25 in-lbs of torque

## 13MHMD - DOUBLE HINGED HEAVY DUTY CLAMP

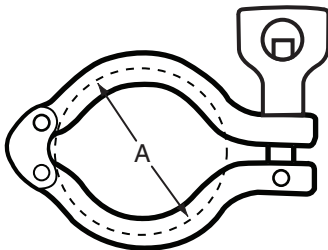

Size Tube OD	A
1 1/2	2.122
2	2.654
2 1/2	3.185
3	3.717
4	4.820

Wing Nuts tightened to 25 in-lbs of torque

## 13MHMD - H - DOUBLE HINGED HEAVY DUTY CLAMP (Wing Nut With Hole)

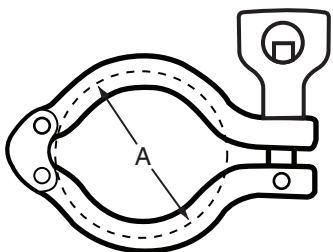

Size Tube OD	A
1 1/2	2.122
2	2.654
2 1/2	3.185
3	3.717
4	4.820

Wing Nuts tightened to 25 in-lbs of torque

## 13MHHS - THREE PIECE HEAVY DUTY CLAMP

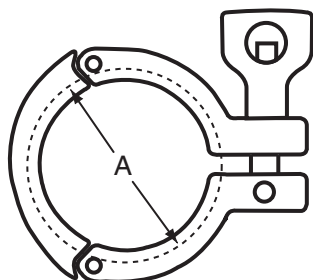

Size Tube OD	A
1 1/2	2.122
2	2.654
2 1/2	3.185
3	3.717
4	4.820

Wing Nuts tightened to 25 in-lbs of torque

Note: One inch fittings take 1 1/2" clamps.  
Fractional fittings take 3/4" clamps.

## 13MHP - HIGH PRESSURE CLAMP

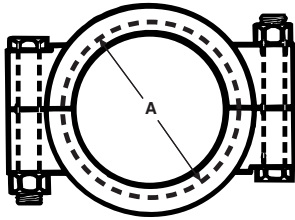

Size Tube OD	A
3/4	1.125
1 1/2	2.046
2	2.578
2 1/2	3.110
3	3.640
4	4.744
6	6.632

13MHP Style nuts tightened to 20 ft-lbs of torque

## EG13 - HINGED CLAMP - (Light Duty)

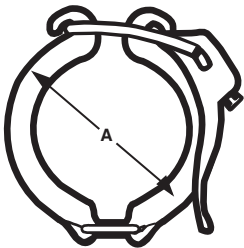

Size Tube OD	A
1 1/2	2.142
2	2.653
2 1/2	3.205
3	3.740
4	4.803

## \*PSI SERVICE RATINGS FOR SANITARY STAINLESS STEEL CLAMPS

Size Tube OD	13MHHM / 13MHHM - H		13MHHMD / 13MHHMD - H	
	@70°F	@250°F	@70°F	@250°F
3/4"	1500	1200		
1 1/2"	500	250	500	250
2"	450	250	450	250
2 1/2"	400	200	400	200
3"	350	150	350	150
4"	200	125	200	125
5"	175	100		
6"	150	75		
8"	100	50		
10"	40	30		
12"	30	25		

Note: One inch fittings take 1 1/2" clamps.  
Fractional fittings take 3/4" clamps.



**\*PSI SERVICE RATINGS FOR SANITARY STAINLESS STEEL CLAMPS**

Size Tube OD	13MHHS		13MHP		EG13	
	@70°F	@250°F	@70°F	@250°F	@70°F	@250°F
3/4"			1500	1200		
1 1/2"	600	300	1500	1200	150	125
2"	550	275	1000	800	150	125
2 1/2"	450	225	1000	800	150	125
3"	350	160	1000	800	150	125
4"	250	150	1000	800	150	125
5"						
6"			300	200		
8"						
10"						
12"						

\*Service ratings are based upon hydrostatic tests using Standard Molded Buna-N gasket material with proper expansion of ferules, joint assembly, and the absence of shock pressure. All ratings systems are dependent upon related components in the system and proper installation. **13MHHS Style nuts tightened to 25 in-lbs of torque / 13MHP Style nuts tightened to 20 ft-lbs of torque.**

**EG28A - 45° CLAMP LATERAL**

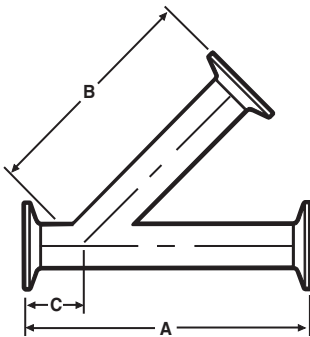

Size Tube OD	A	B	C
1	7.000	5.500	1.500
1 1/2	8.375	6.687	1.687
2	9.625	7.625	2.125
2 1/2	11.125	9.000	2.000
3	11.750	9.375	2.375
4	14.062	11.375	2.687
6	18.875	15.375	4.375

**EG28B - CLAMP TRUE Y**

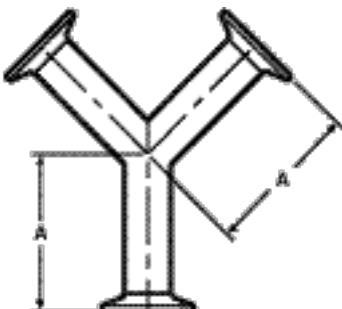

Size Tube OD	A
1	3.500
1 1/2	3.500
2	4.500
2 1/2	5.500
3	6.500
4	8.625
6	8.875

**Note: One inch fittings take 1 1/2" clamps.  
Fractional fittings take 3/4" clamps.**

## EG28RA - 45° CLAMP REDUCING LATERAL

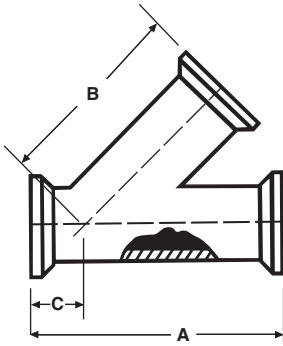

Size Tube OD	A	B	C
1 1/2 x 1	8.375	5.062	1.375
2 x 1	9.625	5.500	1.625
2 x 1 1/2	9.625	5.500	1.625
2 1/2 x 1	11.125	6.875	2.125
2 1/2 x 1 1/2	11.125	6.875	2.125
2 1/2 x 2	11.125	6.875	2.125
3 x 1	11.750	8.250	2.500
3 x 1 1/2	11.750	8.250	2.500
3 x 2	11.750	8.250	2.500
3 x 2 1/2	11.750	8.250	2.500
4 x 1	14.062	10.000	3.000
4 x 1 1/2	14.062	10.000	3.000
4 x 2	14.062	10.000	3.000
4 x 2 1/2	14.062	10.000	3.000
4 x 3	14.062	10.000	3.000

## EG31CC - CONCENTRIC REDUCER

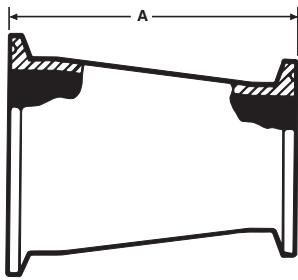

Size Tube OD	A
3/4 x 1/2	2.000
1 x 1/2	2.000
1 x 3/4	2.000
1 1/2 x 1/2	3.000
1 1/2 x 3/4	3.000
1 1/2 x 1	3.000
1 1/2 x 1 1/4	2.000
2 x 1	5.000
2 x 1 1/4	2.000
2 x 1 1/2	3.000
2 1/2 x 1	7.000
2 1/2 x 1 1/2	5.000
2 1/2 x 2	3.000
3 x 1 1/2	7.000
3 x 2	5.000
3 x 2 1/2	3.000
4 x 2	9.125
4 x 2 1/2	7.125
4 x 3	5.125
6 x 3	6.875
6 x 4	7.000

**Note: One inch fittings take 1 1/2" clamps.  
Fractional fittings take 3/4" clamps.**

## EG32CC - ECCENTRIC REDUCER

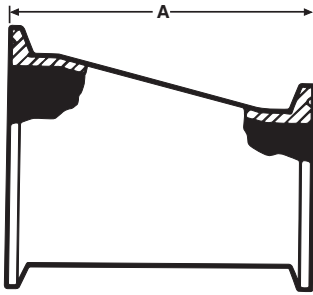

Size Tube OD	A
3/4 x 1/2	2.000
1 x 1/2	3.000
1 x 3/4	2.000
1 1/2 x 1/2	5.000
1 1/2 x 3/4	4.000
1 1/2 x 1	3.000
1 1/2 x 1 1/4	2.000
2 x 1	5.000
2 x 1 1/4	2.000
2 x 1 1/2	3.000
2 1/2 x 1	7.000
2 1/2 x 1 1/2	5.000
2 1/2 x 2	3.000
3 x 1 1/2	7.000
3 x 2	5.000
3 x 2 1/2	3.000
4 x 2	9.125
4 x 2 1/2	7.125
4 x 3	5.125
6 x 3	6.875
6 x 4	7.000

## EG31PC - ADAPTER REDUCER (Concentric)

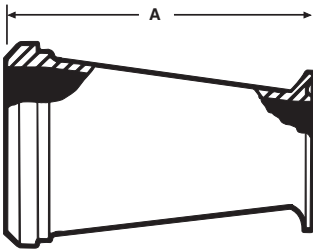

Size Tube OD	A
*1 1/2 x 1	3.187
2 x 1	5.218
2 x 1 1/2	3.218
2 1/2 x 1 1/2	5.343
2 1/2 x 2	3.343
3 x 2	5.437
3 x 2 1/2	3.437
4 x 2 1/2	7.500
4 x 3	5.500

\*Hex nut furnished

Note: One inch fittings take 1 1/2" clamps.  
Fractional fittings take 3/4" clamps.

## EG32PC - ADAPTER REDUCER (Eccentric)

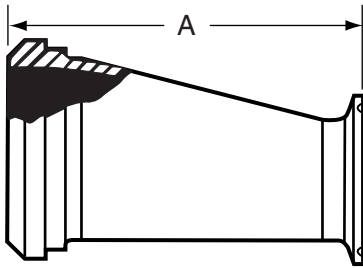

Size Tube OD	A
*1 1/2 x 1	3.187
2 x 1	5.218
2 x 1 1/2	3.218
2 1/2 x 1 1/2	5.343
2 1/2 x 2	3.343
3 x 2	5.437
3 x 2 1/2	3.437
4 x 2 1/2	7.500
4 x 3	5.500

\*Hex nut furnished

## EG31CP - ADAPTER REDUCER (Concentric)

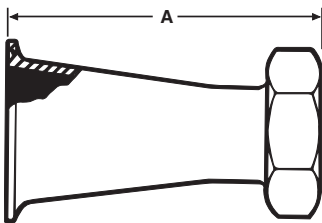

Size Tube OD	A
1 1/2 x 1	3.875
2 x 1	5.875
2 x 1 1/2	4.000
2 1/2 x 1 1/2	6.000
2 1/2 x 2	4.000
3 x 2	6.000
3 x 2 1/2	4.250
4 x 2 1/2	8.378
4 x 3	6.378

## EG32CP - ADAPTER REDUCER (Eccentric)

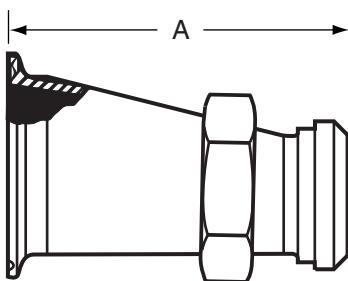

Size Tube OD	A
1 1/2 x 1	3.875
2 x 1	5.875
2 x 1 1/2	4.000
2 1/2 x 1 1/2	6.000
2 1/2 x 2	4.000
3 x 2	6.000
3 x 2 1/2	4.250
4 x 2 1/2	8.378
4 x 3	6.378

Note: One inch fittings take 1 1/2" clamps.  
Fractional fittings take 3/4" clamps.

## EG31TC - ADAPTER REDUCER (Concentric)

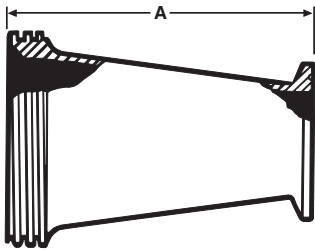

Size Tube OD	A
1 1/2 x 1	3.187
2 x 1	5.218
2 x 1 1/2	3.218
2 1/2 x 1 1/2	5.343
2 1/2 x 2	3.343
3 x 2	5.437
3 x 2 1/2	3.437
4 x 2 1/2	7.500
4 x 3	5.500

## EG32TC - ADAPTER REDUCER (Eccentric)

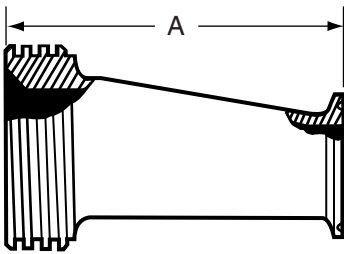

Size Tube OD	A
1 1/2 x 1	3.187
2 x 1	5.218
2 x 1 1/2	3.218
2 1/2 x 1 1/2	5.343
2 1/2 x 2	3.343
3 x 2	5.437
3 x 2 1/2	3.437
4 x 2 1/2	7.500
4 x 3	5.500

## EG31CT - ADAPTER REDUCER (Concentric)

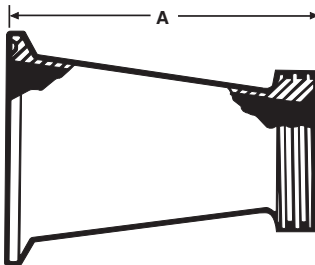

Size Tube OD	A
1 1/2 x 1	3.187
2 x 1	5.187
2 x 1 1/2	3.187
2 1/2 x 1 1/2	5.187
2 1/2 x 2	3.218
3 x 1 1/2	7.187
3 x 2	5.218
3 x 2 1/2	3.343
4 x 2	9.343
4 x 2 1/2	7.468
4 x 3	5.562

Note: One inch fittings take 1 1/2" clamps.  
Fractional fittings take 3/4" clamps.

## EG32CT - ADAPTER REDUCER (Eccentric)

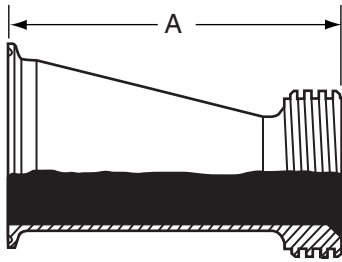

Size Tube OD	A
1 1/2 x 1	3.187
2 x 1	5.187
2 x 1 1/2	3.187
2 1/2 x 1 1/2	5.187
2 1/2 x 2	3.218
3 x 1 1/2	7.187
3 x 2	5.218
3 x 2 1/2	3.343
4 x 2	9.343
4 x 2 1/2	7.468
4 x 3	5.562

## CLAMP FITTINGS SCHEDULE 5 & 10

### EG2CS-5-6L - FERRULE

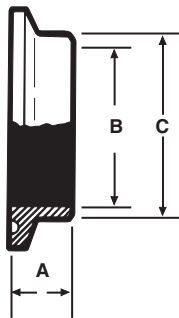

Size Pipe	A	B	C	Nom. Wall
1	0.500	1.185	1.315	0.065
1 1/2	0.500	1.770	1.900	0.065
2	0.500	2.245	2.375	0.065
2 1/2	0.500	2.709	2.875	0.083
3	0.500	3.334	3.500	0.083
4	0.625	4.334	4.500	0.083

### EG2CS-10-6L - FERRULE

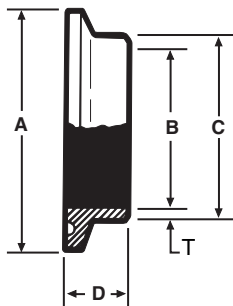

Size Pipe	A	B	C	D	Nom. Wall
1/2	1.984	0.674	0.840	0.500	0.083
3/4	1.984	0.884	1.050	0.500	0.083
1	1.984	1.097	1.315	0.500	0.109
1 1/2	2.516	1.682	1.900	0.500	0.109
2	3.047	2.157	2.375	0.500	0.109
2 1/2	3.579	2.635	2.875	0.500	0.120
3	4.125	3.260	3.500	0.500	0.120
4	5.125	4.260	4.500	0.625	0.120

### EG14AM7-5-6L - FERRULE

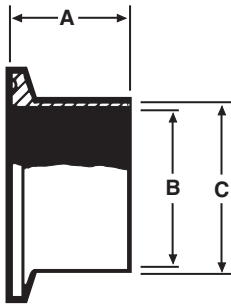

Size Pipe	A	B	C	Nom. Wall
1	1.125	1.185	1.315	0.065
1 1/2	1.125	1.770	1.900	0.065
2	1.125	2.245	2.375	0.065
2 1/2	1.125	2.709	2.875	0.083
3	1.125	3.334	3.500	0.083
4	1.125	4.334	4.500	0.083

### EG14AM7-10-6L - FERRULE

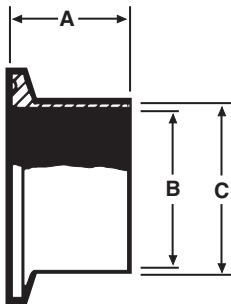

Size Pipe	A	B	C	Nom. Wall
1	1.125	1.097	1.315	0.109
1 1/2	1.125	1.682	1.900	0.109
2	1.125	2.157	2.375	0.109
2 1/2	1.125	2.635	2.875	0.120
3	1.125	3.260	3.500	0.120
4	1.125	4.260	4.500	0.120

### EG16A-5-6L - CAP

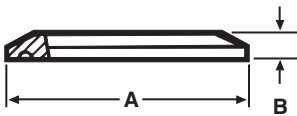

Size Pipe	A	B
1	1.984	0.250
1 1/2	2.516	0.250
2	3.047	0.250
2 1/2	3.579	0.250
3	4.125	0.250
4	5.125	0.250

### 13MHM-5 - CLAMP

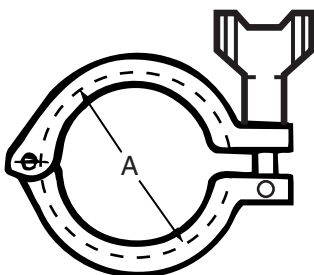

Size Pipe	A
1	2.122
1 1/2	2.654
2	3.185
2 1/2	3.717
3	4.250
4	5.250

### \*PSI SERVICE RATINGS FOR SANITARY STAINLESS STEEL CLAMPS

Pipe Size	13MHHM	
	@70°F	@250°F
1"	500	250
1 1/2"	450	250
2"	400	200
2 1/2"	350	150
3"	250	135
4"	175	100

### GASKETS



Gasket Materials	Part Number
Buna N	EG40-5-SIZE
Teflon	EG40T-5-SIZE
Viton	EG40V-5-SIZE
Silicone	EG40S-5-SIZE
EPDM	EG40E-5-SIZE

Available in 1" to 4" sizes.

**Note: One inch fittings take 1 1/2" clamps.  
Fractional fittings take 3/4" clamps.**