

**Operating Instructions
for
Electronic Temperature Switch**

Model: TDD



1. Contents

1. Contents.....	2
2. Note	3
3. Instrument Inspection.....	3
4. Regulation Use.....	3
5. Operating Principle.....	4
6. Mechanical Connection.....	4
7. Electrical Connection	5
7.1. Connector pin assignment TDD-153, TDD-353	5
7.2. Connector pin assignment TDD-553, TDD-753	6
8. Commissioning.....	7
8.1. Button function.....	7
9. Adjustments	8
9.1. Value setting	8
10. Set- up Mode	9
10.1. Adjustments for TDD-1... and TDD-3.....	9
10.2. Adjustments for TDD-5...; TDD-7.....	10
11. Main Menu Options	12
11.1. Switching point.....	12
11.2. Hysteresis	12
11.3. Window point (Double Point), (only for TDD-1... and TDD-3...)	12
11.4. Switching behaviour.....	13
11.5. Filter (only for TDD-1... and TDD-3...).....	14
11.6. Transient response (only for TDD-5... and TDD-7...).....	14
11.7. Contact model.....	15
11.8. Change Code.....	15
12. Maintenance	15

Manufactured and sold by:

Kobold Messring GmbH
Nordring 22-24
D-65719 Hofheim
Tel.: +49(0)6192-2990
Fax: +49(0)6192-23398
E-Mail: info.de@kobold.com
Internet: www.kobold.com

2. Note

Please read these operating instructions before unpacking and putting the unit into operation. Follow the instructions precisely as described herein.

The devices are only to be used, maintained and serviced by persons familiar with these operating instructions and in accordance with local regulations applying to Health & Safety and prevention of accidents.

When used in machines, the measuring unit should be used only when the machines fulfil the EWG-machine guidelines.

3. Instrument Inspection

Instruments are inspected before shipping and sent out in perfect condition.

Should damage to a device be visible, we recommend a thorough inspection of the delivery packaging. In case of damage, please inform your parcel service / forwarding agent immediately, since they are responsible for damages during transit.

Scope of delivery:

The standard delivery includes:

- Electronic Temperature Switch model: TDD
- Operating Instructions

4. Regulation Use

Any use of the Electronic Temperature Switch, model: TDD, which exceeds the manufacturer's specification may invalidate its warranty. Therefore any resulting damage is not the responsibility of the manufacturer. The user assumes all risk for such usage.

5. Operating Principle

The KOBOLD Model TDD temperature sensor is used for economical measuring and monitoring of temperature. It can be used for any application in which temperatures must be monitored with great accuracy.

The sensor element is a semiconductor that outputs a digital signal to the electronic processor in 0,5 °C steps. The measured values are shown on a 3-digit LED display. The switch setpoint can be adjusted as required within the measuring range.

6. Mechanical Connection

Before installation:

- Please check, if the switching temperature and switching function of TDD device is in agreement with your system requirements (specifications).
- Ensure that the maximum operating pressure or temperature for the device is not exceeded.

Installation:

- This device is installed in a matching sleeve. Use sealing tape (i.e. PTFE tape) or a flat gasket to seal the threaded connections.
- The mounting position should be selected so that the sensor tip is always immersed in the liquid being monitored, thus ensuring optimal heat exchange between the liquid and the temperature sensor.
- Note that deposits that build up on the sensor tip or dirty liquids can have an insulating effect and cause invalid measurements.
- Whenever possible, after the mechanical installation is complete, the joint at the threaded connector and the supply piping should be checked to ensure that it is tight and does not leak.

7. Electrical Connection



Attention! Make sure that the supply voltage of your system correspond with the voltage of the measuring unit specified on the nameplate.

- Make sure that the electrical supply lines are de-energised.
- Make the connection using the M 12x1 connector socket, as shown in the accompanying diagram.
- Appropriate connectors with different cable lengths are optionally available.



Attention! Incorrect wiring will lead to damage of the unit's electronics.

7.1. Connector pin assignment TDD-153, TDD-353

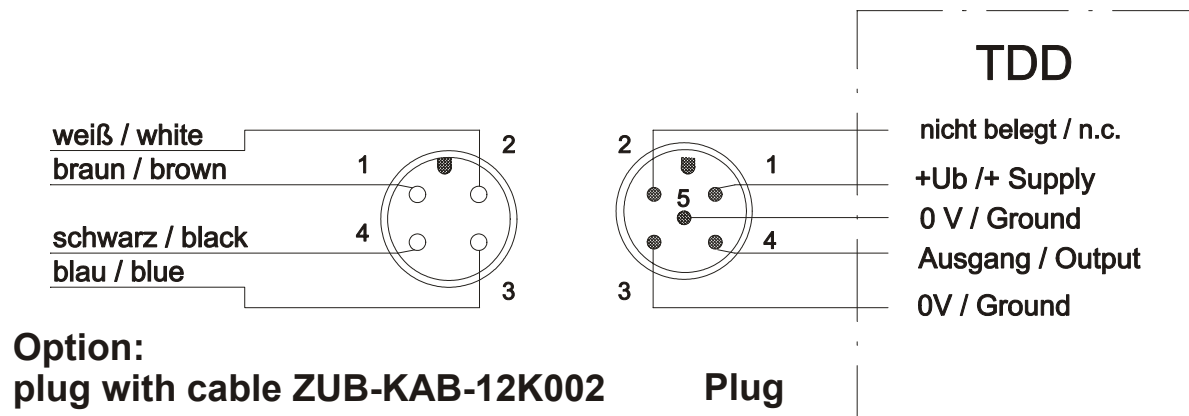

7.2. Connector pin assignment TDD-553, TDD-753

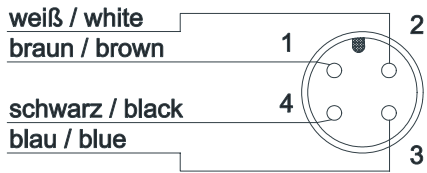

Accessories
Socket with cable
ZUB-KAB-12K002

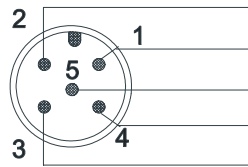

Plug

TDD-...553	TDD-...753
PNP-Output 1	NPN-Output 1
+24 V _{DC}	+24 V _{DC}
0 V / GND	0 V / GND
PNP-Output 2	NPN-Output 2
0 V / GND	0 V / GND

PNP connection scheme

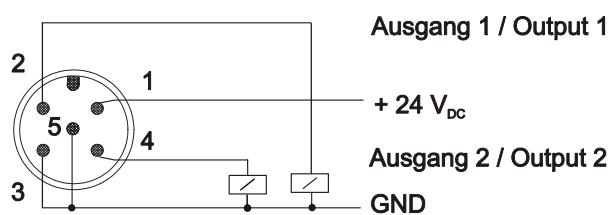

Plug

NPN Connection Scheme

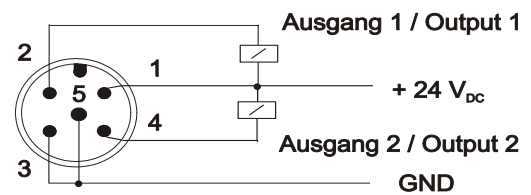

Plug

8. Commissioning





Attention! Please take note that during operation at high temperatures, the surface and the elements within the unit may become very hot!

Connect the temperature switch according to the figure shown on the previous page, and supply the device with the specified voltage.

8.1. Button function



In the normal mode (measurement mode)

	: Press 3 sec → set-up mode
	: Switch point/display window point
	: Switch point/display hysteresis

TDD-1

TDD-5 and TDD-7

In adjustment mode

	: Next level
	: Change values

Anytime:
3 sec 
or 20 sec
Don't press any key
↓
Normal Mode

9. Adjustments

The following values can be changed at the temperature transmitter:

	Display range	Factory pre-set
Switching point (SPo , set-point)	-199...999	50.0
Hysteresis (HYS)	-199...0	000
Window point (double)	Switching point ...999	--- (inactive)
Filter (Filt)	1/2/4/8/16/32/64	1
Contact-Type (Con)	Contact (N/O) or (N/C)	N/O Contact
Code (CCo , change code)	000...999	000

9.1. Value setting

From main menu option (e.g. Switching point, "SPo"), press "◆" key in order to go to Parameter Adjustment. The following structure shows the sequence of steps required to change a single parameter.

[From main menu option]

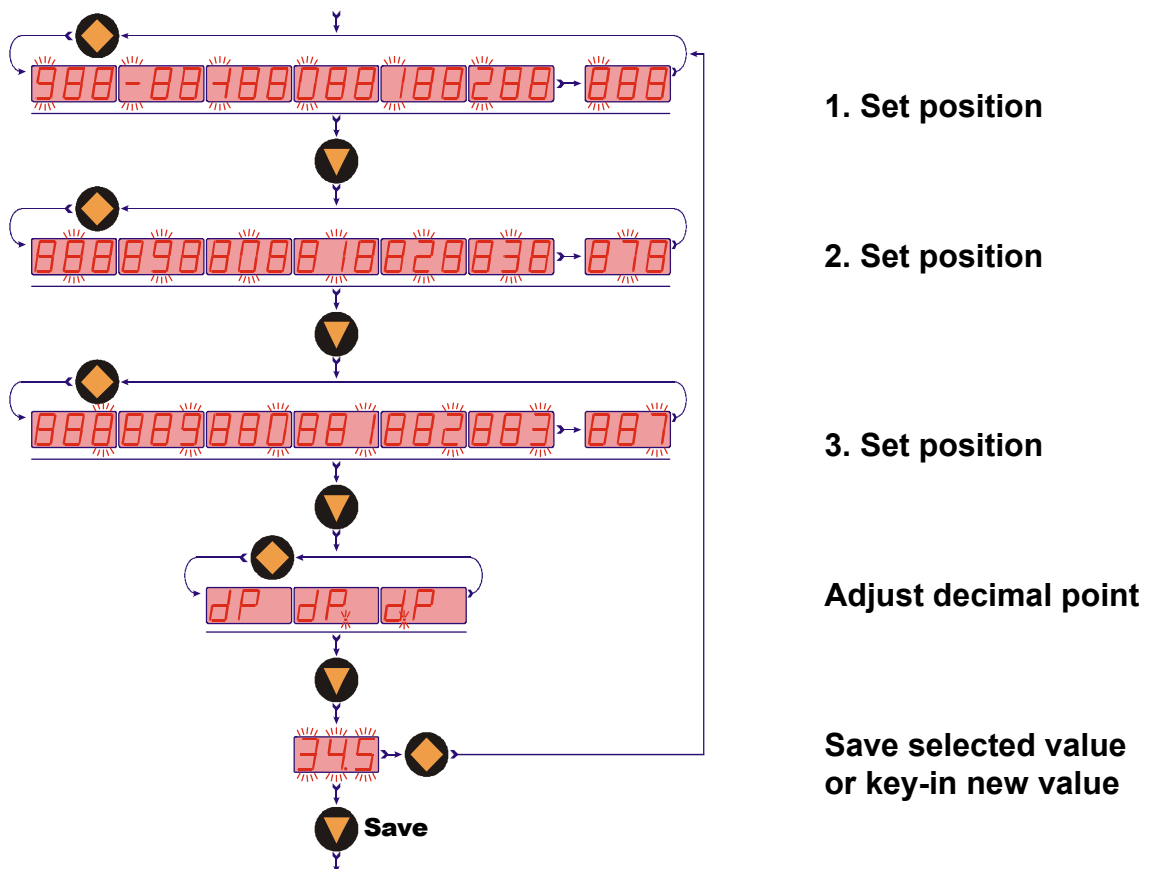

[to next main menu option]

10. Set- up Mode

10.1. Adjustments for TDD-1... and TDD-3...

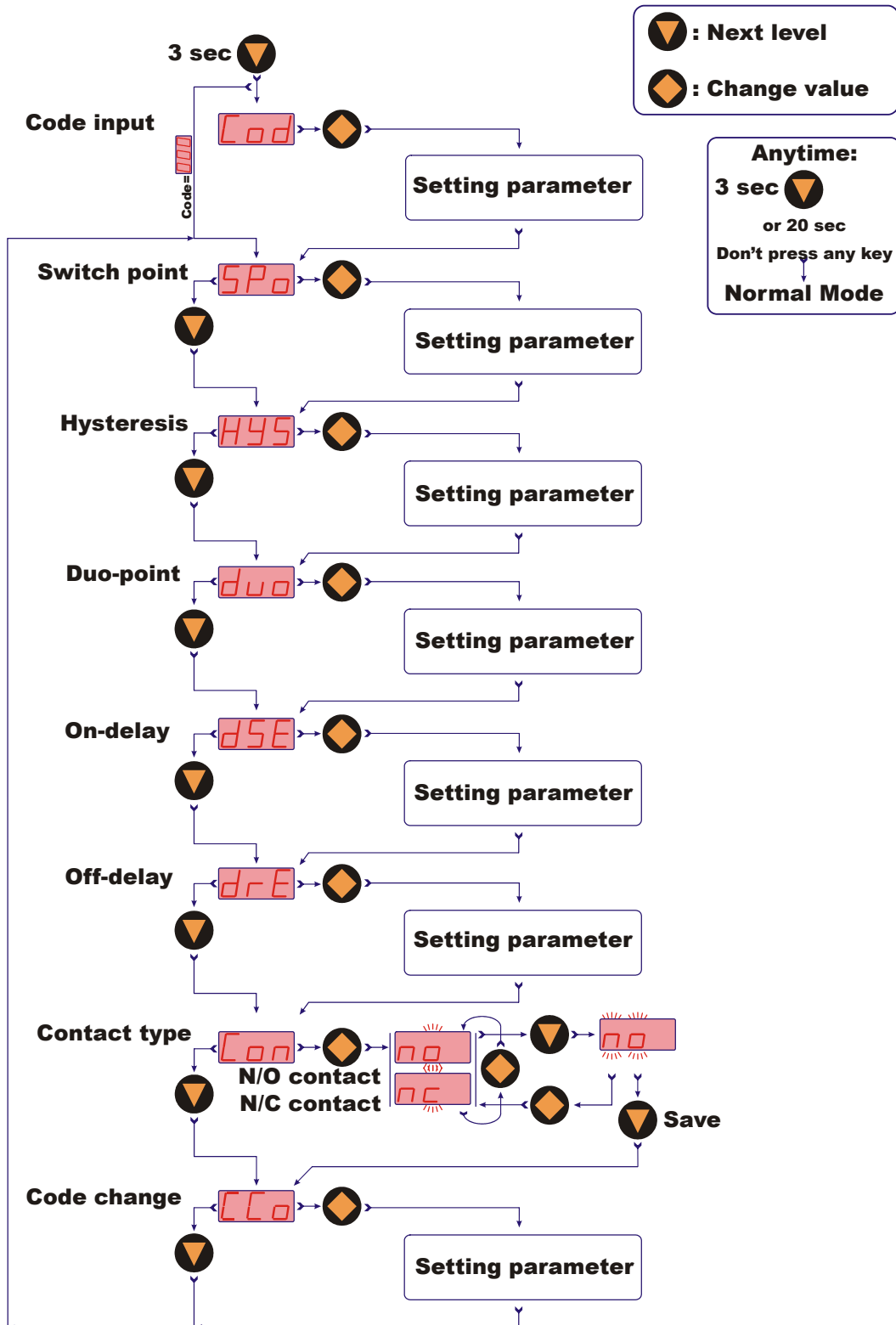

10.2. Adjustments for TDD-5...; TDD-7...

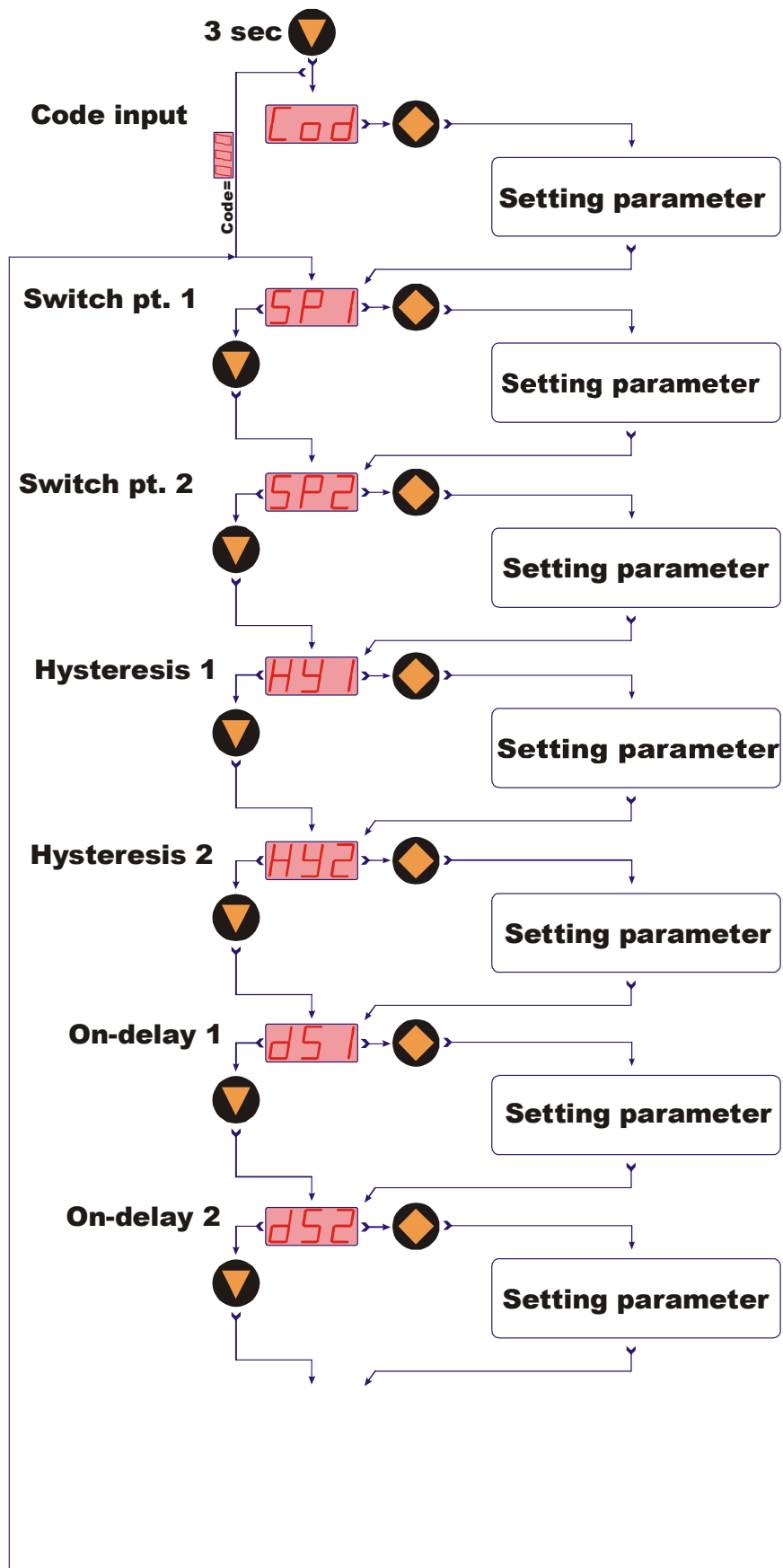

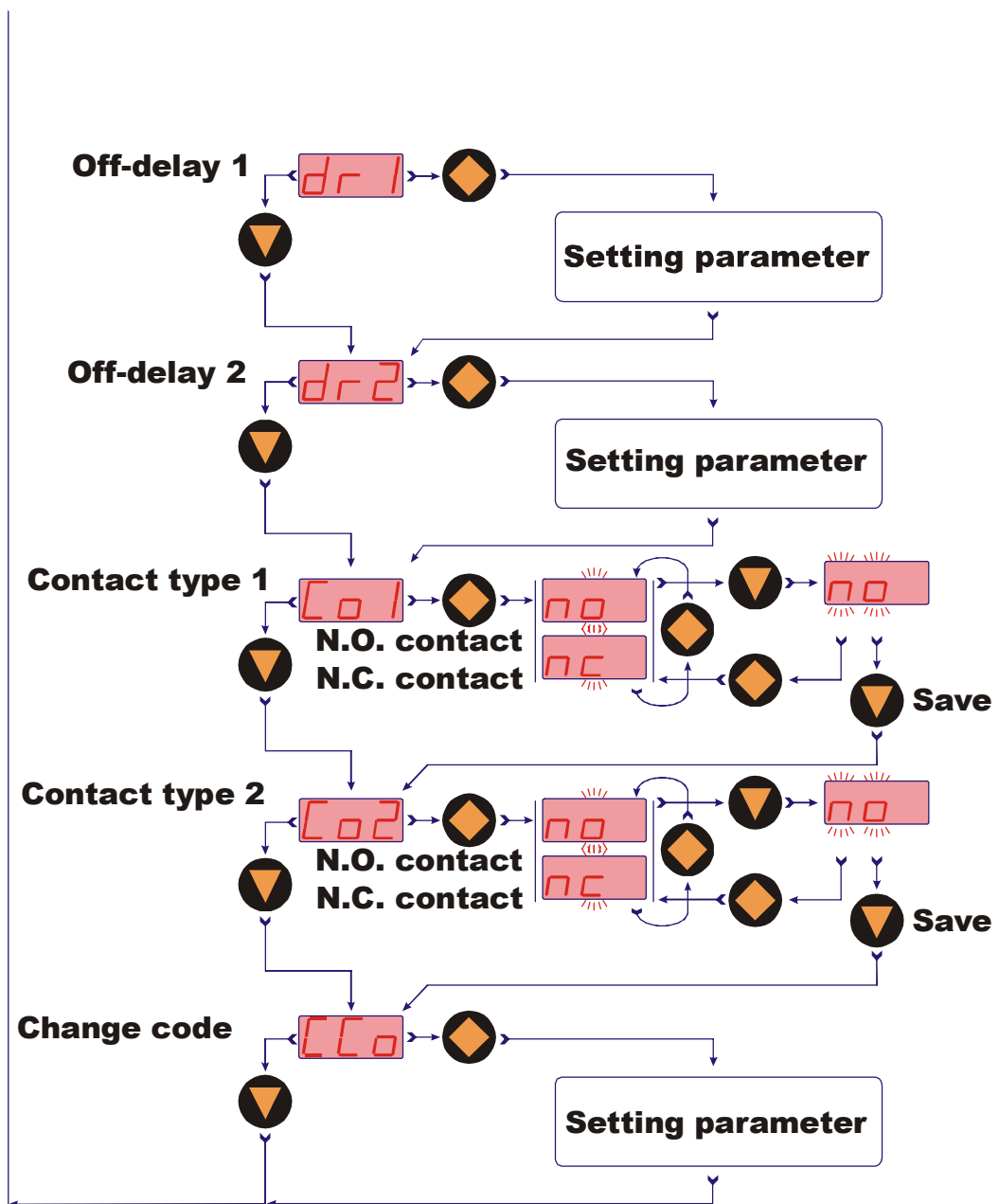

11. Main Menu Options

11.1. Switching point

In menu option "SP0", "SP1" and "SP2" the switching point is entered. A setting value between -199 and 999 can be selected. This value can also include a decimal point. The decimal point can be set at two points (e.g. 10.0 or 100). If the measuring value is the set switch point, the temperature switch is activated and is signalised by a lightning LED.

If the hysteresis is zero and the window point is inactive, the temperature switch will be reacted if the temperature is below the switch point.

11.2. Hysteresis

After the setting of switching point, the hysteresis can be entered as a negative value in the "HYS", "HY1" and "HY2" menu. The standard hysteresis value is zero. In operation condition this can lead to ambiguous switching behaviour if the reading fluctuates around the switching point or window point. Aid can be given here by increasing the hysteresis. The hysteresis relates to the switching point and the window point (switching point minus hysteresis; window point plus hysteresis).

Example: Switching point 100 °C; Hysteresis: -2.5 °C

The temperature switch switches when 100 °C is exceeded and switches back when the reading drops below 97.5 °C.

11.3. Window point (Double Point), (only for TDD-1... and TDD-3...)

As well as the switching point, it is also to define a "duo" (duo-point), the window point. This must be higher than the switching point. Using the window point and the switching point it is possible to monitor the measurement value in a certain range. The switching point limits the measurement range to smaller values and the window point to larger values.



If the window point (duo-point) is less than or equal to the switching point, an error report (Er4) will be indicated on the display and its value is deleted and its function is invalid (in the case that the window point and switching point out of adjustment).

The value is set in the same way as the switching point.

The window point is needed for process, monitoring of a certain temperature range.

Example: Switching point: 50 °C; window point: 70 °C; hysteresis: -2 °C
 The temperature contact switches when 50 °C is exceeded.
 If the temperature remain between 48 °C (50-2) and 72 °C (70+2), the contact will also remain in active switching condition (LED on). If it exceeds 72 °C or drops below 48 °C the temperature switch switches back.

11.4. Switching behaviour

The following diagram clarifies the switching behaviour of the temperature switch. The contact closes (contact type: no) when it drops below the switching point or the window point. It only opens again if the window point plus hysteresis is exceeded or if it drops below the switching point minus hysteresis. An LED indicates the switching condition of the switching point.

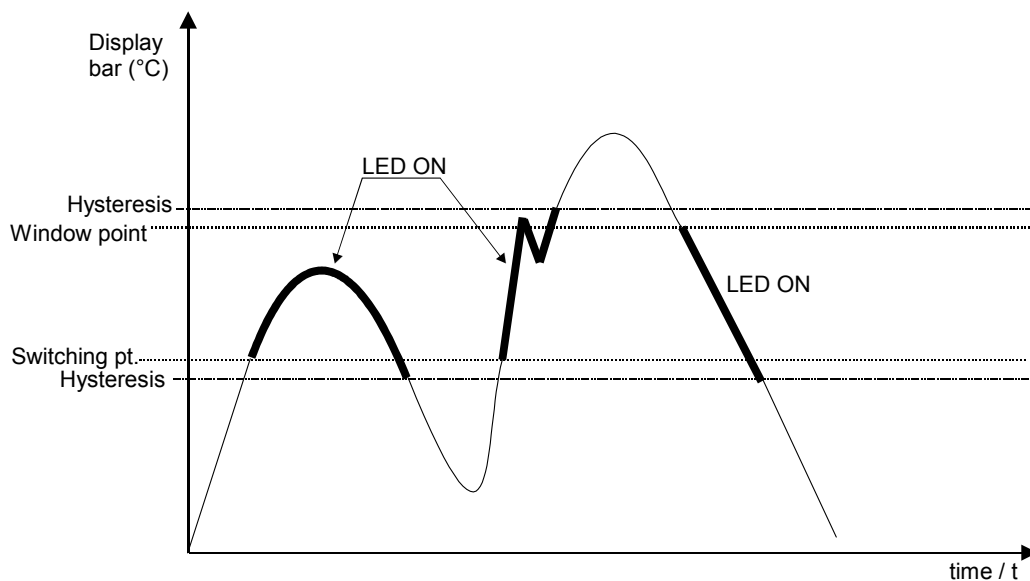
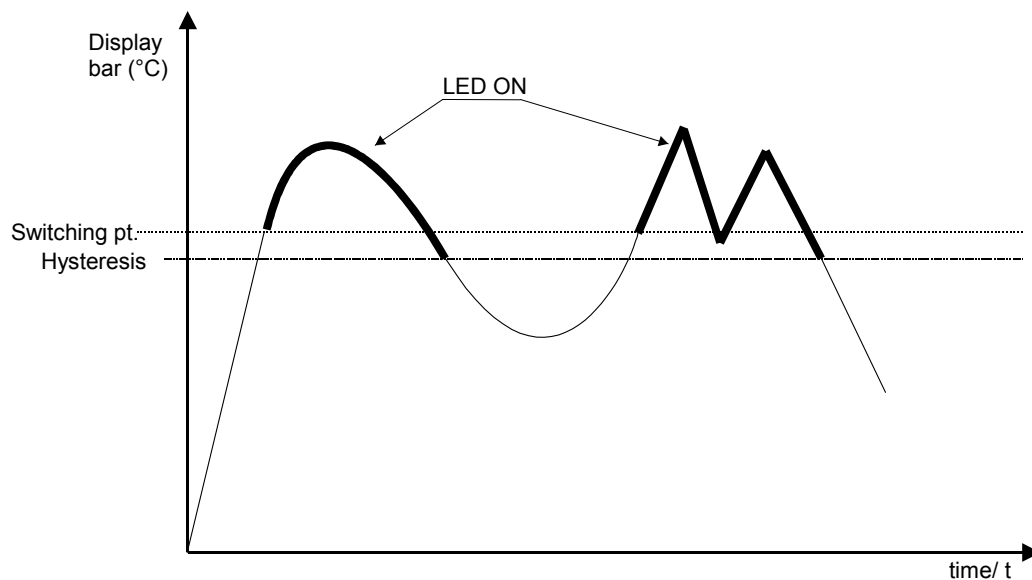

11.5. Filter (only for TDD-1... and TDD-3...)

The filter function "**Filt**" makes the measured value for switching purposes the running average from the measured value samples. The following values can be adjusted (see section 9. Adjustments):

1 / 2 / 4 / 8 / 16 / 32 / 64 samples

The filter value determines the dynamic behaviour of the display value. The larger the **Filt** value, the more dampened the display response. With the adjustment of the filter value " 1 " the filter is switched off, i.e. the display value is equal to the unfiltered measured value.

The integrated overshoot detector reacts to a step change of approx. 6.25% of the measurement range (full scale). During a detected measured value overshoot of >6.25%, the instantaneous measured value is transferred directly to the display without filtering.

11.6. Transient response (only for TDD-5... and TDD-7...)

Using the menu items "**ds1**", "**ds2**", "**dr1**" and "**dr2**" it is possible to set the delay set and the delay reset.

The delay set causes delayed switching of the output if the switching threshold is exceeded.

The delay reset causes a delayed resetting of the output if it drops below the switching threshold – hysteresis.

The setting range for both parameters is 0.0 ... 99.5 seconds. The step rate is 0.5 seconds.

With these two functions it is also possible to suppress temporary disturbances.

11.7. Contact model

In menu option "**Con**", "**Co1**" and "**Co2**" the transistor switching output function is set. The switching function changes from

N/O contact

to

N/C contact, and back.

N/O contact means: Contact closes on exceeding the switching point.

N/C contact means: Contact opens on exceeding the switching point.

11.8. Change Code

The code change "**CCo**" protects the device against unauthorised changes in adjusted device parameters. If the code is different from 000, the user must input the adjusted code in order to perform any programming changes.

12. Maintenance

This device is maintenance-free when properly installed. However, deposits from dirty liquids can lead to invalid measured values.